



Snowdragon Industrial Co.,Ltd

DATA SHEET

MODEL No : **SD580BCX**

ENG. No:

Description:

- 5mm Blue
- Blue (Water clear)
- 100 mA
- Viewing angle: 80-85°

Chip GalnN

PREPARED BY	CHECKED BY	APPROVED BY
CUSTOMER APPROVED SIGNATURES		

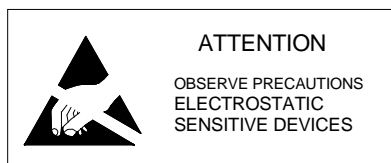



Features:

- Single color
- High bright output
- Medium power consumption
- High reliability and long life

Descriptions:

- Dice material: GaInN
- Emitting Color: Super Bright Blue
- Device Outline: ϕ 5mm Round Type
- Lens Type: Water Clear

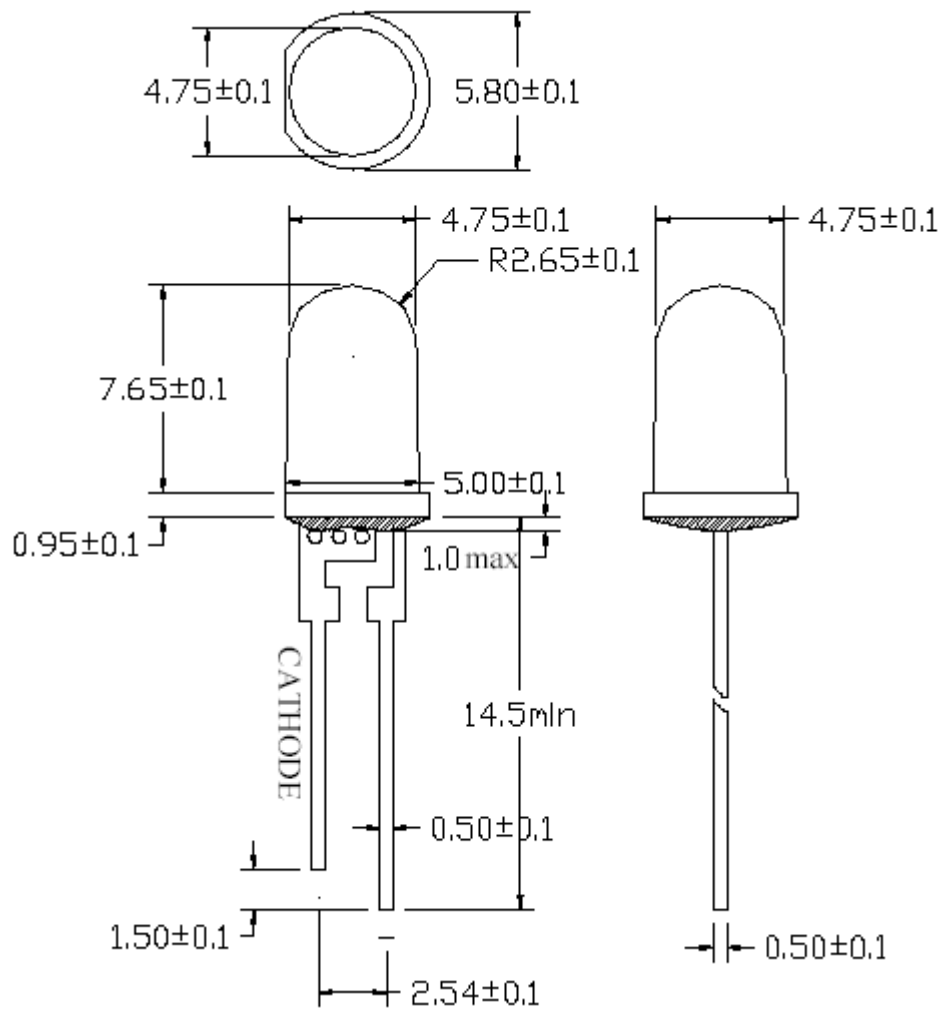

NOTE:

- All dimensions are millimetres.
- Tolerance is +/-0.25mm unless otherwise noted

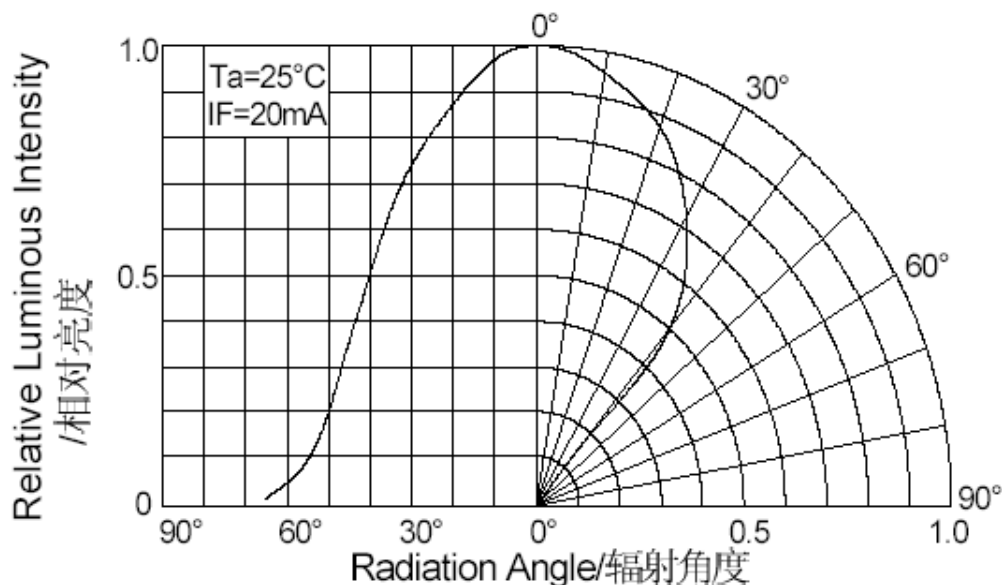

Absolute maximum ratings (Ta = 25°C)

Parameter	Symbol	Test Condition	Value		Unit
			Min.	Max.	
Reverse Voltage	V _R	I _R = 30 μA	5	--	V
Forward Current	I _F	----	----	100	mA
Power Dissipation	P _d	----	----	0.5	W
Pulse Current	I _{peak}	Duty=0.1mS, 1kHz	----	200	mA
Operating Temperature	T _{opr}	----	-20	+85	°C
Storage Temperature	T _{str}	----	-25	+100	°C

Electrical and optical characteristics (Ta = 25°C)

Parameter	Symbol	Test Condition	Value			Unit
			Min.	Typ.	Max.	
Forward Voltage	V _F	I _F = 100mA	3.4	----	4	V
Reverse Current	I _R	V _R = 5V	----	----	30	μA
Luminous Flux	Φ _v	I _F = 100mA	2.8	----	4.7	lm
Color Temperature	CCT	I _F = 100mA	----	----	----	K
Viewing Angle	2θ 1/2	I _F = 100mA	----	85	----	Deg.



Luminous Flux Bins (Ta = 25°C)

Unit:lm

Bin	F	G	H	J	K	L
Min	1.3	1.7	2.2	2.8	3.6	4.7
Max	1.7	2.2	2.8	3.6	4.7	6.0

Typical electrical/optical characteristic curves:

Fig.1 正向电流 Vs. 正向电压

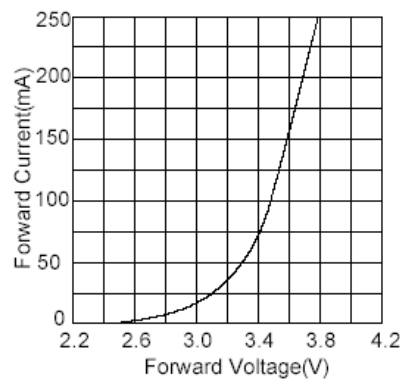

Fig.2 相对亮度 Vs. 正向电流

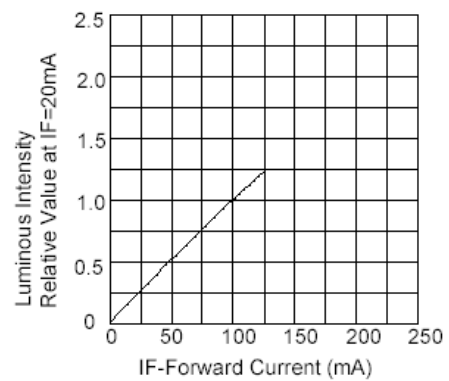

Fig.3 正向电流 Vs. 环境温度

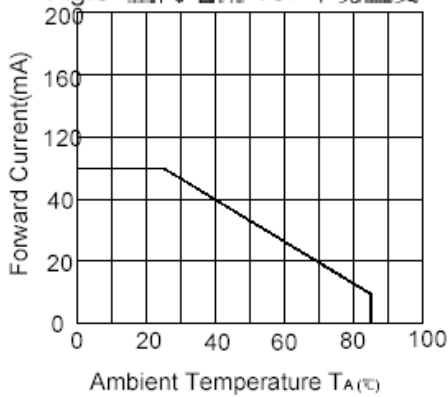

Fig.4 相对亮度 Vs. 环境温度

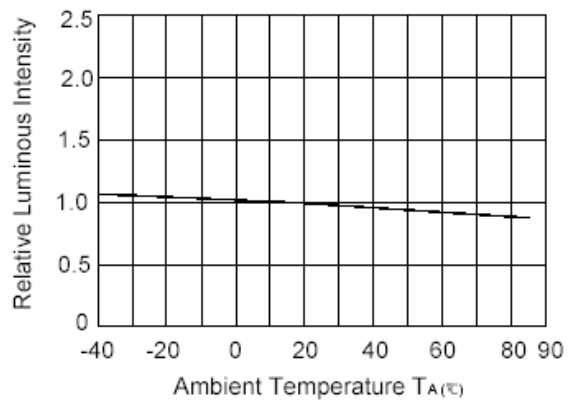



Fig.5 相对亮度 Vs. 波长

