



Snowdragon Industrial Co.,Ltd

DATA SHEET

MODEL No : SDP358RWX-0-SI-Q

ENG. No:

Description:

- 358 Rectangular lamp
- Lens Color: Diffused
- Emitting Color: Red
- Viewing Angle :120°
- No Stopper

Dice Material: AlGaInP

PREPARED BY	CHECKED BY	APPROVED BY
CUSTOMER APPROVED SIGNATURES		

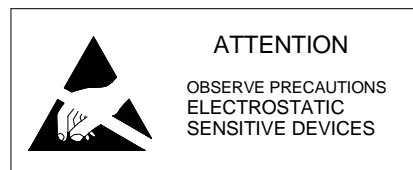

Applications:

Dimension Drawing

--

Model No.	SDP358RWX-0-SI-Q
Revision:	

Absolute Maximum Ratings at Ta = 25°C

Items	Symbol	Absolute maximum Rating	Unit
Forward Current	I _F	25	mA
Peak Forward Current*	I _{FP}	100	mA
Reverse Voltage	V _R	5	V
Power Dissipation	P _D	100	mW
Operation Temperature	T _{opr}	-20 ~ +75	°C
Storage Temperature	T _{stg}	-30 ~ +80	°C
Lead Soldering Temperature	T _{sol}	Max.260°C for 3 sec Max. (3mm from the base of the epoxy bulb)	

*pulse width <=0.1msec duty <=1/10

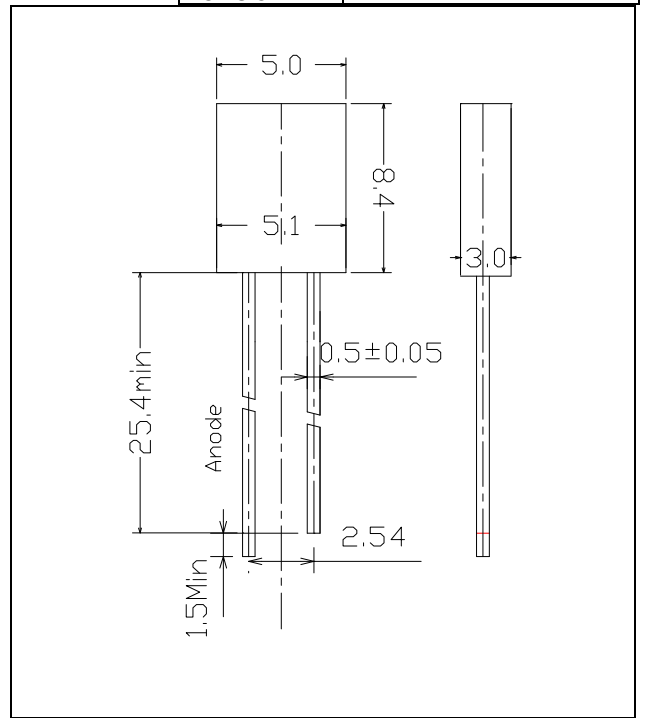

Typical Electrical & Optical Characteristics (Ta = 25°C)

Items	Symbol	Condition	Min.	Typ.	Max.	Unit
Forward Voltage	I _F = 20mA	---	1.8v	2.2v	2.6v	I _F = 20mA
Reverse Current	V _R = 5V	---	---	---	10μA	V _R = 5V
Wavelength	I _F = 20mA	---	---	625nm	---	I _F = 20mA
Luminous Intensity	I _F = 20mA	--	---	100mcd	---	I _F = 20mA
50% Power Angle	I _F = 20mA	---	---	120 deg	---	I _F = 20mA
	I _F = 20mA	---	---	---	---	I _F = 20mA

Rank	Luminous Intensity(mcd)	Rank	Luminous Intensity(mcd)	Rank	Luminous Intensity(mcd)
/	/	/	/	/	/

Important Notes:

- 1) All ranks will be included per delivery, rank ratio will be determined by Snowdragon
- 2) Tolerance of measurement of luminous intensity is ±15%.
- 3) Tolerance of measurement of dominant wavelength is ±1nm.
- 4) Tolerance of measurement of Vf is ±0.05 V.
- 5) Packaging methods are available for selection, please refer to PACKAGING STANDARD.
- 6) Please refer to LED LAMP RELIABILITY TEST STANDARD for reliability test conditions.

Typical Optical-Electronic Characteristic Curves

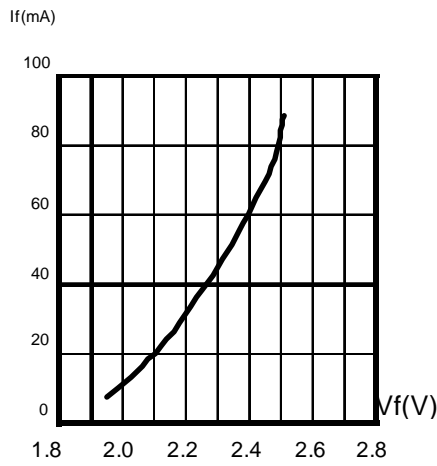

Fig.1 FORWARD CURRENT VS. FORWARD VOLTAGE.

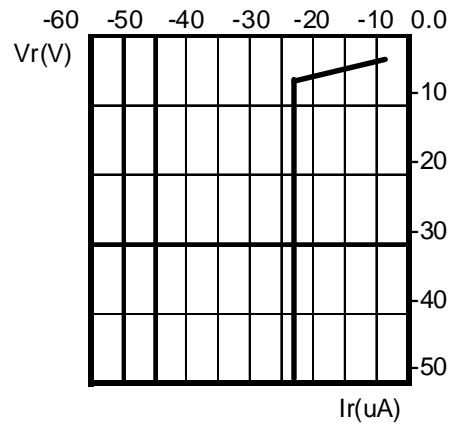

Fig.2 REVERSE CURRENT VS. REVERSE VOLTAGE.

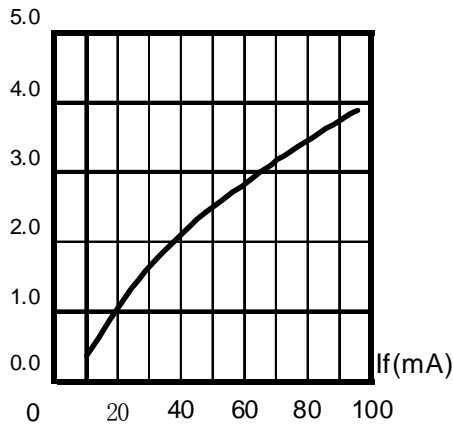

Fig.3 RELATIVE LUMINOUS INTENSITY VS. FORWARD CURRENT.

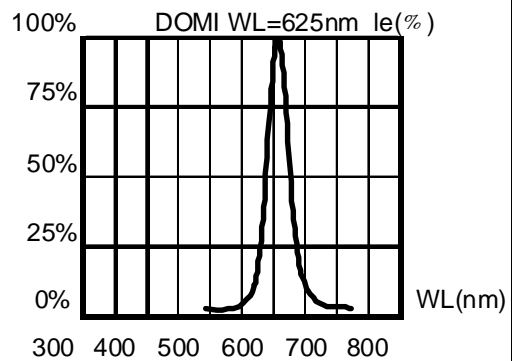
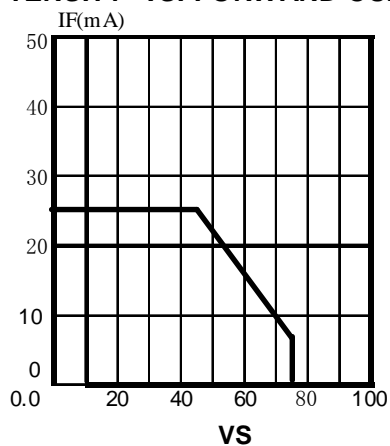

Fig.4 RELATIVE LUMINOUS INTENSITY VS. WAVELENGTH.



VS AMBIENT TEMPERATURE(Tjmax=105°C)

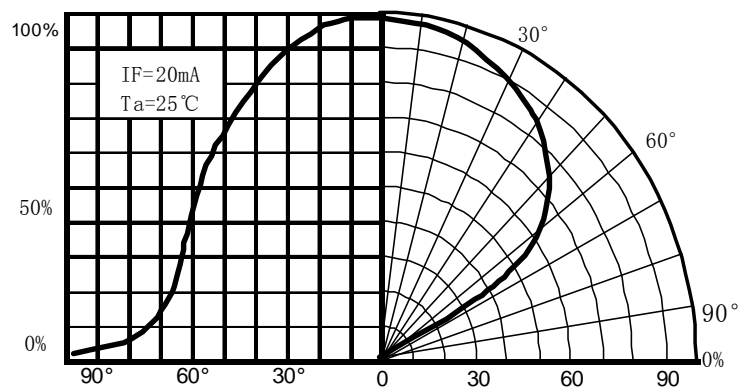

Fig.6 FAR FIELD PATTERN

LED Lamp Reliability test standard

Type	Test Item	REF. Standard	Test conditions		Note	Number of Damaged
			Binary / Trinary Chip	Quaternary Chip		
Environments Sequence	Temperature Cycle	JIS C7021 (1977)A4	-20°C ~25°C ~80°C ~25°C 30min,5min,30min,5min	-40°C ~25°C ~100°C ~25°C 30min,5min,30min,5min	100 cycles	0/100
	Thermal shock	MIL-STD-202G	-20°C ~80°C 30min, 30min	-40°C ~100°C 30min, 30min	100 cycles	0/100
	High Temperature Storage(*)	JIS C7021 (1977)B10	Ta=80°C	Ta=100°C	1000Hrs	0/100
	Low Temperature Storage	JIS C7021 (1977)B12	Ta=-30°C	Ta=-40°C	1000Hrs	0/100
Operation Sequence	Life test	JIS C7035 (1985)	Ta=25°C If=25mA	Ta=25°C If=25mA	1000Hrs	0/100
	High humidity Heat life test	-----	60°C RH=90% If=20mA	60°C RH=90% If=20mA	500Hrs	0/100
	Low temperature Life test	-----	Ta=-20°C If=20mA	Ta=-30°C If=20mA	1000Hrs	0/100
Destructive Sequence	Resistance to solderingHeat	JIS C7021 (1977)A11	Tsol=260±5°C ,10sec. (3mm from the base of the epoxy bulb)		1 time	0/20
	Solder ability	JIS C7021 (1977)A2	Tsol=235±5°C ,5sec. (using flux)		1 time (over95%)	0/20
	Lead Pull/Bend Test	JIS C7021 (1977)A11	Load 2.5N(0.25kgf) 0°C ~90°C ~0°C ;Bend 3times		3 time	0/10
ESD Test	ESD TEST	AEC (Q101002)	Human body model 1000v		-----	0/10

Items marked with * are selective.

Failure Criteria

Item	Symbol	Test Condition	Criteria for Judgment	
			min	Max
Forward Voltage	VF	IF = 20 mA	-----	Initial Data x 1.1
Reverse Current	IR	VR = 5 V	-----	100 A
Luminous Flux/Intensity	/IV	IF = 20 mA	Initial Data x 0.7 (Total degradation) Initial Data x 0.5 (Single lamp degradation)	